



fröschler

fallon vct + mms





Fallon VCT, der professionelle Auftritt als Teil Ihrer Identität. Für die gelungene Videokonferenz und Präsentation eng verbunden mit dem konventionellen Dialog durch integrierte Elektrifizierungsmöglichkeiten. Öffnungswinkel von 0–180° wählbar – Standard 15°.

Fallon VCT, a professional presentation as part of your identity. Here you have the right means for a successful video conference and presentation in combination with a conventional dialog by integrated electrification possibilities. Opening angle of 0–180° selectable – standard 15°.



Elegantes Design in hochwertiger Verarbeitung. **mms – mobiles medien sideboard.** mobil – für eine flexible und einfache Positionierung in Ihrem Unternehmen. Vier Lenkrollen für ein einfaches Handling. Beamer und 200W Soundsystem integriert. Textile Netzblende für optimale Beschallung. Beamer auf Podest für Feinjustierung bei Bodenunebenheiten. Schublade mit Stauraum für DVD, CD, Prospekte. Klappe für PC und Integration weiterer Technik-elemente. 8-fach Steckleiste für zentrales Powermanagement. Rückseite mit großer Klappe für schnelles und einfaches Installieren.

Elegant design in high-quality processing. **mms – mobile media sideboard.** mobility – for a flexible and simple positioning in your company. Four castors for a simple handling. Projector and 200W sound system are integrated. Textile netdazzles for optimal acoustic irradiation. Projector on a shelf for easy adjustment in case of surface irregularities. Drawer with storage room for DVD, CD, folders. Flap for PC and integration for further technology elements. Eightfold connector strip for central power management. Back of the sideboard with a large flap for fast and simple installation.





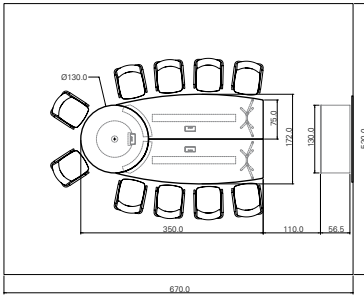

Länge 350 cm
Breite 172 cm
Öffnungswinkel 15°

Length 350 cm
Width 172 cm
Opening angle 15°

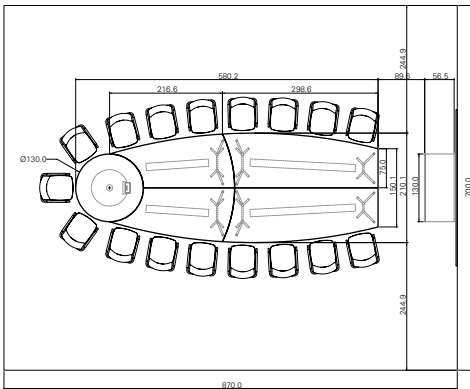
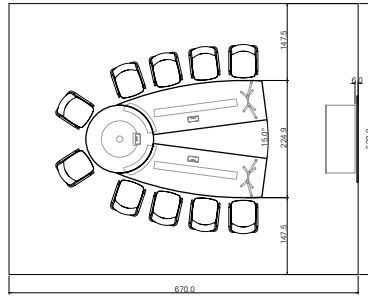

Länge 580,2 cm
Breite 210,1 cm
Öffnungswinkel 20°

Length 580,2 cm
Width 210,1 cm
Opening angle 20°

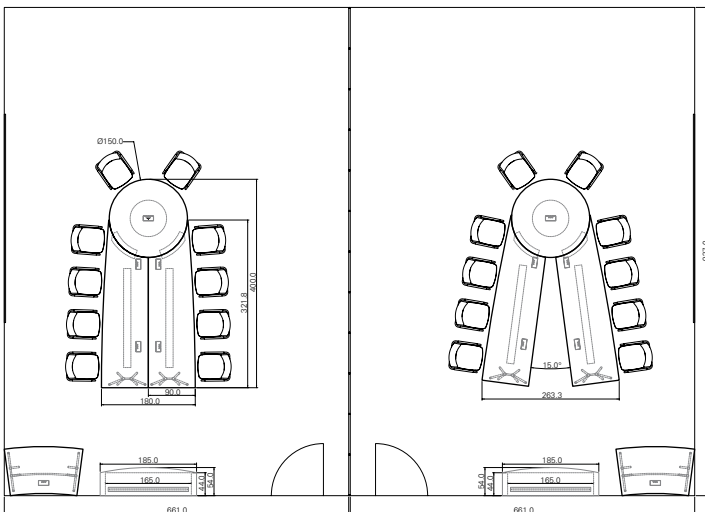
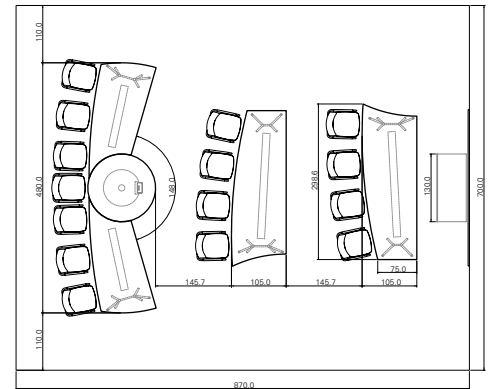
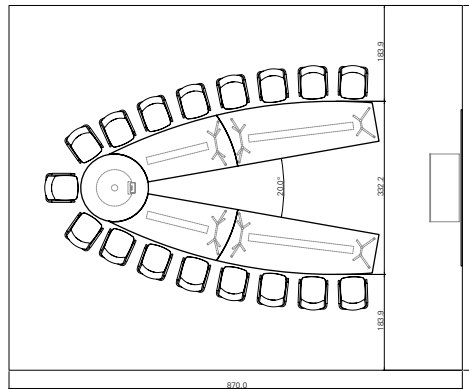

Länge 400 cm
Breite 180 cm
Öffnungswinkel 15°

Length 400 cm
Width 180 cm
Opening angle 15°

Rundelement im
Durchmesser 130 cm.
Optional 110 und 150 cm.

Round element in
diameter 130 cm.
Optionally 110 and 150 cm.

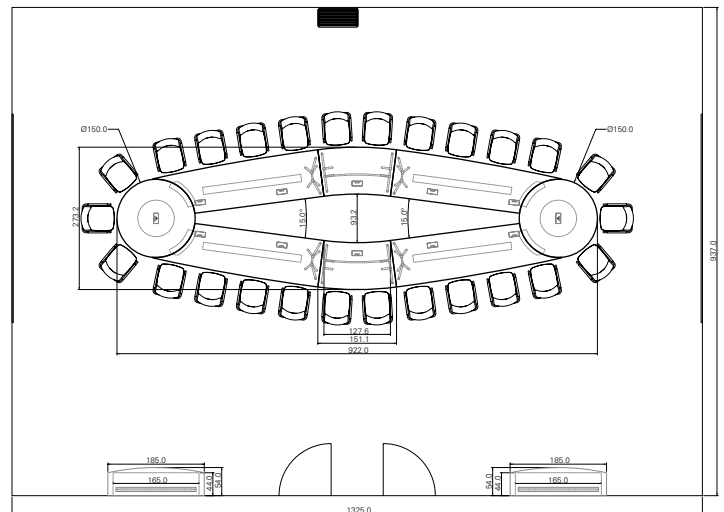

**Fröscher
GmbH & Co.KG
Stühle und Tische**

Bahnhofstraße 20
D-71711 Steinheim/Murr
Germany

Telefon +49(0)7144-2040
Telefax +49(0)7144-204114

www.froescher.com
marketing@froescher.com